

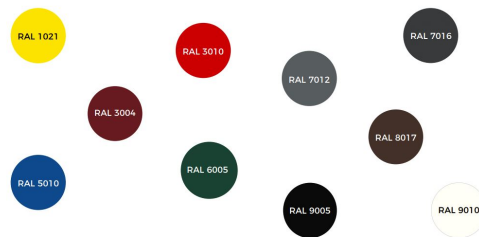

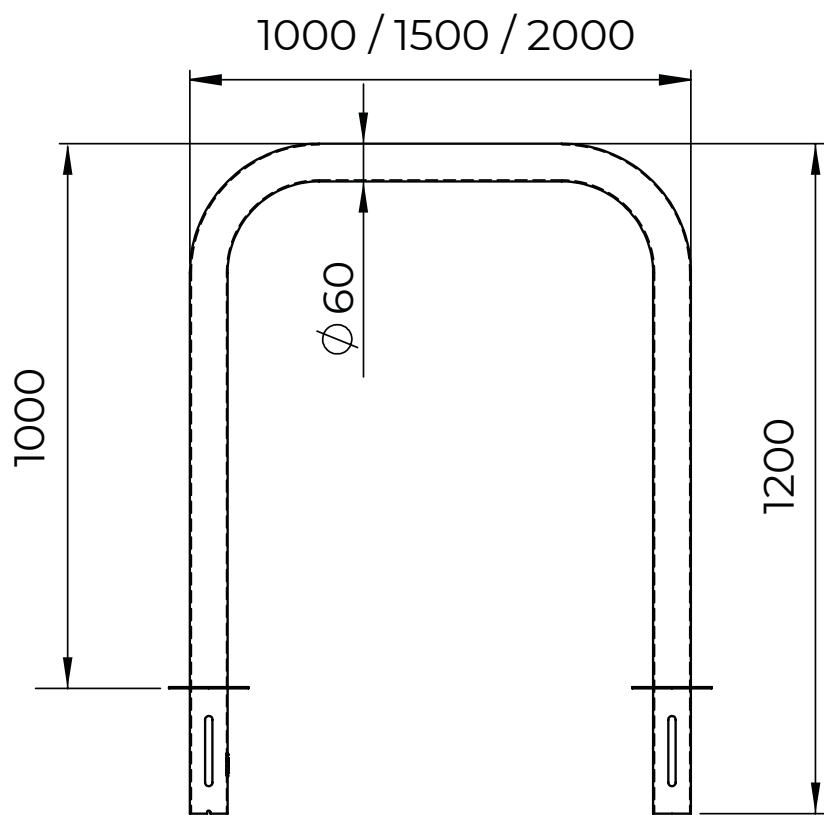

ARCEAU DE PROTECTION

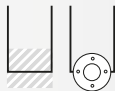

 <p>FIXATIONS</p> <p>À sceller ou sur platine</p>	 <p>MATIÈRE</p> <p>Galvanisé ou galvanisé Peint</p>	 <p>DIAMÈTRES</p> <p>60</p>	 <p>HAUTEURS</p> <table border="1"> <tr> <td>HORS SOL</td> <td>HORS TOUT</td> </tr> <tr> <td>1000</td> <td>1200</td> </tr> </table>	HORS SOL	HORS TOUT	1000	1200	 <p>OPTION</p> <p>Autre RAL avec plus-value</p>
HORS SOL	HORS TOUT							
1000	1200							