

## Jardinière CANTORODADO 200 - 742L



**Description** : Jardinière en béton hydrofugé.

### **Dimensions**

Hauteur : 500mm

Diamètre supérieure : Ø2000mm

Diamètre inférieure : Ø1720mm

Capacité : 742L

Poids : 1060kg

**Coloris standards** : Blanc, gris, marron, ocre, noir.

Autres couleurs sur demande avec plus-value.



**AVENIR VOIRIE**

☎ 02 97 63 94 31  
✉ info@avenir-voirie.fr

**Référence : CANTORODADO 200**

### Couleurs de finition

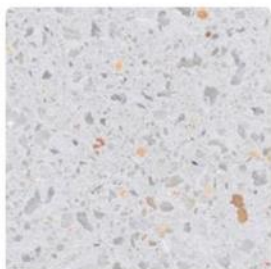

Blanc



Gris



Marron



Ocre



Noir

### Optionnel

Fini hors moule

### Autres coloris (Consulter)

Consulter

Augmentation en pourcentage en fonction de la couleur. *Demander un devis.*

### Finitions de surface



Bronze



Corten



Golden



Noir graphite

Revêtements composés de liants qui intègrent des charges de métal concassé et donnent aux éléments urbains l'apparence réelle du métal ainsi que son oxydation et ne se détériorent pas avec le temps.

GEOMETRIA / GEOMETRY

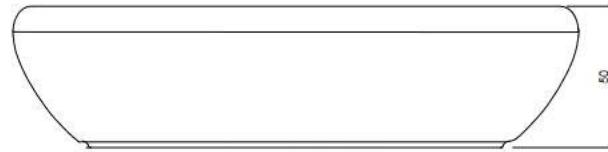

ALZADO / FRONT VIEW

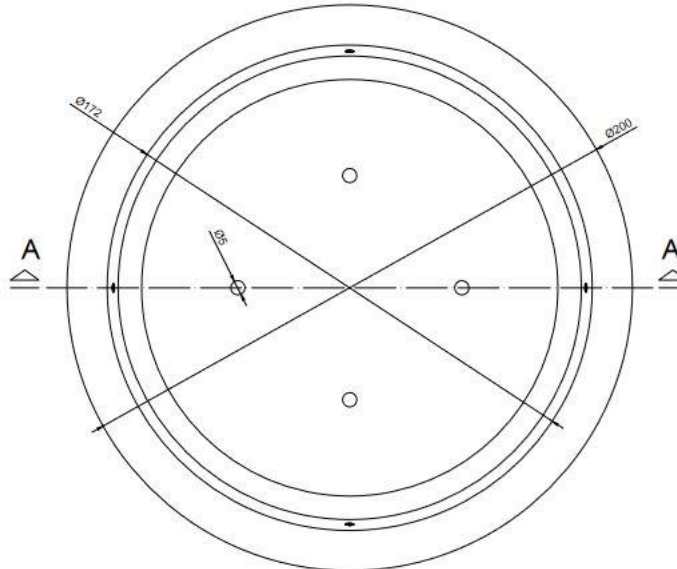

PLANTA / TOP VIEW

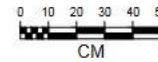

MANIPULACIÓN E INSTALACIÓN / HANDLING AND INSTALLATION

1 extraer tapas / extract stoppers

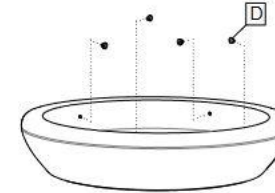

2 enroscar cáncamo / thread the eyebolt

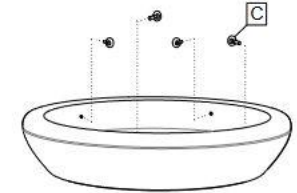

3 perforar y verter resina epoxy  
perforer un trou et verser résine epoxy

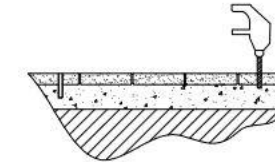

4 insertar la varilla en el agujero  
insérez la tige de métal dans le trou

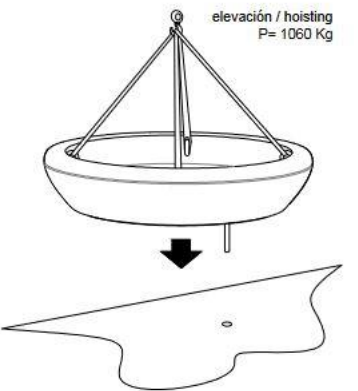
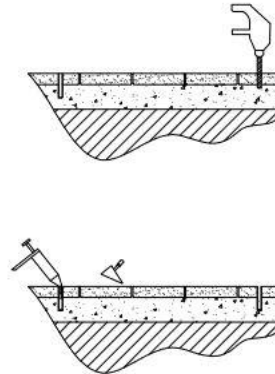

SISTEMA DE FIJACIÓN / ANCHORAGE SYSTEM

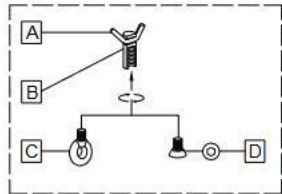
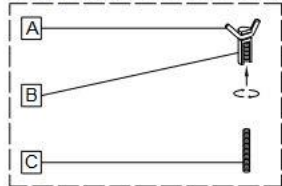

SISTEMA DE ELEVACIÓN / LIFTING SYSTEM

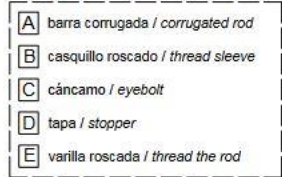

ESPECIFICACIONES / SPECIFICATIONS

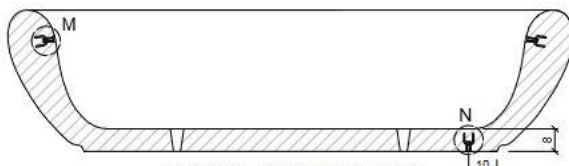

SECCIÓN A-A' / SECTION A-A'

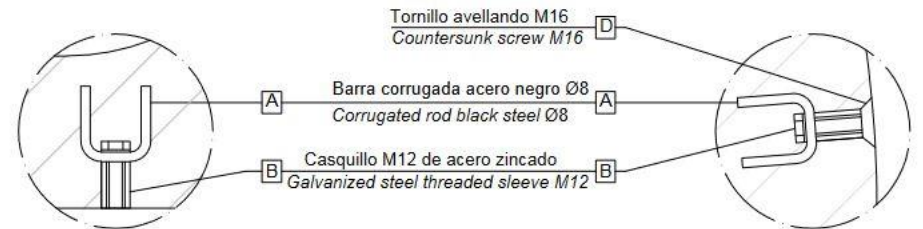

DETALLE N / DÉTAIL N

DETALLE M / DETAIL M

Tornillo avellando M16  
Countersunk screw M16

Barra corrugada acero negro Ø8  
Corrugated rod black steel Ø8

Casquillo M12 de acero zincado  
Galvanized steel threaded sleeve M12